

Design Example Using STR5A453D:

10.5 W (15 V, 0.7 A)

Off-line Buck Converter

Precautions for High Voltage



Dangerously high voltages exist inside the demonstration board.
Mishandling the demonstration board may cause the death or serious injury of a person.
Before using the demonstration board, read the following cautions carefully, and then use the demonstration board correctly.

DO NOT touch the demonstration board being energized.

Dangerously high voltages that can cause death or serious injury exist inside the demonstration board being energized.

Electrical shock may be caused even by accidental short-time contact or by putting hands close to the demonstration board.

Electrical shock can result in death or serious injury.
Before touching the demonstration board, make sure that the capacitors have been discharged.

For safety purpose, an operator familiar with electrical knowledge must handle the demonstration board.

The demonstration board is for evaluation of all the features of the STR5A453D.
The demonstration board shall not be included or used in your mass-produced products.
Before using the demonstration board, see this document and refer to the STR5A453D data sheet.
Be sure to use the demonstration board within the ranges of the ratings for input voltage, frequency, output voltage, and output current.
Be sure to strictly maintain the specified ambient environmental conditions, such as ambient temperature and humidity.

Contents

Precautions for High Voltage-----	2
1. Introduction -----	4
2. Power Supply Features-----	4
3. Applications -----	4
4. Design Example: Appearance-----	4
5. Design Example-----	5
5.1 Power Supply Specifications -----	5
5.2 Circuit Diagram -----	5
5.3 Bill of Materials-----	6
5.4 Pattern Layout Example-----	7
6. Design Example: Basic Operations -----	8
7. Designing the Power Supply -----	9
7.1 Setting an Output Voltage -----	9
7.2 Calculating an Inductance-----	9
7.2.1 PWM Switching Modes -----	9
7.2.2 Parameter Definitions -----	11
7.2.3 Calculating an Inductance-----	14
7.2.4 Considering Optimization -----	16
7.3 Selecting the Bridge Rectifier Diode BR1 -----	17
7.4 Selecting the Freewheeling Diode D1, VCC Power Supply Diode D3, and Feedback Diode D3-----	17
7.5 Selecting the Bleeder Resistor R5 -----	17
8. Performance Data -----	18
8.1 Efficiency-----	18
8.2 Standby Power -----	19
8.3 Line Regulation -----	19
8.4 Load Regulation -----	20
9. Operation Check -----	21
9.1 Startup Operation-----	21
9.1.1 Power Supply IC Switching Operation -----	21
9.1.2 Output Voltage-----	22
9.2 Power Supply IC Switching Operation -----	23
9.2.1 Normal Operation-----	23
9.2.2 Light-load Operation (Green Mode) -----	24
9.2.3 No-load Operation (Burst Oscillation) -----	24
9.3 Output Ripple Voltage -----	25
9.4 OCP and OLP Operations-----	26
9.5 OVP Operation -----	27
9.6 Shutdown Operation-----	27
9.7 Case Temperature-----	28
10. Conducted Emission Test-----	29
Important Notes-----	31

1. Introduction

This document describes the design example of a power supply using the STR5A453D intended for the non-isolated buck converter that supports universal inputs and a 15 V/0.7 A output (0.8 A peak). The STR5A453D is a current mode PWM control IC with a built-in power MOSFET, developed for configuring non-isolated buck converters. In addition, the design example uses the SJPD-L5 as a fast recovery diode for the freewheeling diode, the SJPB-D9 as a Schottky diode for the IC's power supply, and the SJPD-D5 as a fast recovery diode for the feedback diode.

This document contains the following: the specifications of the design example, circuit diagrams, the bill of materials, the setting examples of component constants, a pattern layout example, and the evaluation results of the power supply characteristics. For more details on the parts listed in this document, refer to the corresponding data sheets.

2. Power Supply Features

- Reduced Number of External Components (Built-in Startup Circuit)
- High Efficiency in All Load Ranges Achieved by Load-based Auto-shifting Operation Modes
 - Normal Operation: PWM Mode, 60 kHz (Typ.)
 - Light-load Operation: Green Mode
 - Standby Operation: Burst Oscillation Mode
- Efficiency: 84.1% (230 VAC, 10.5 W)
- Input Power at No Load: 62.3 mW (230 VAC)
- Reduced EMI Noise (Random Switching Function)

3. Applications

- Small Home Appliance
- Large Home Appliance
- Auxiliary Power Supply
- Power Supply for Motor Control
- Other SMPSs (Switching Mode Power Supplies)

4. Design Example: Appearance

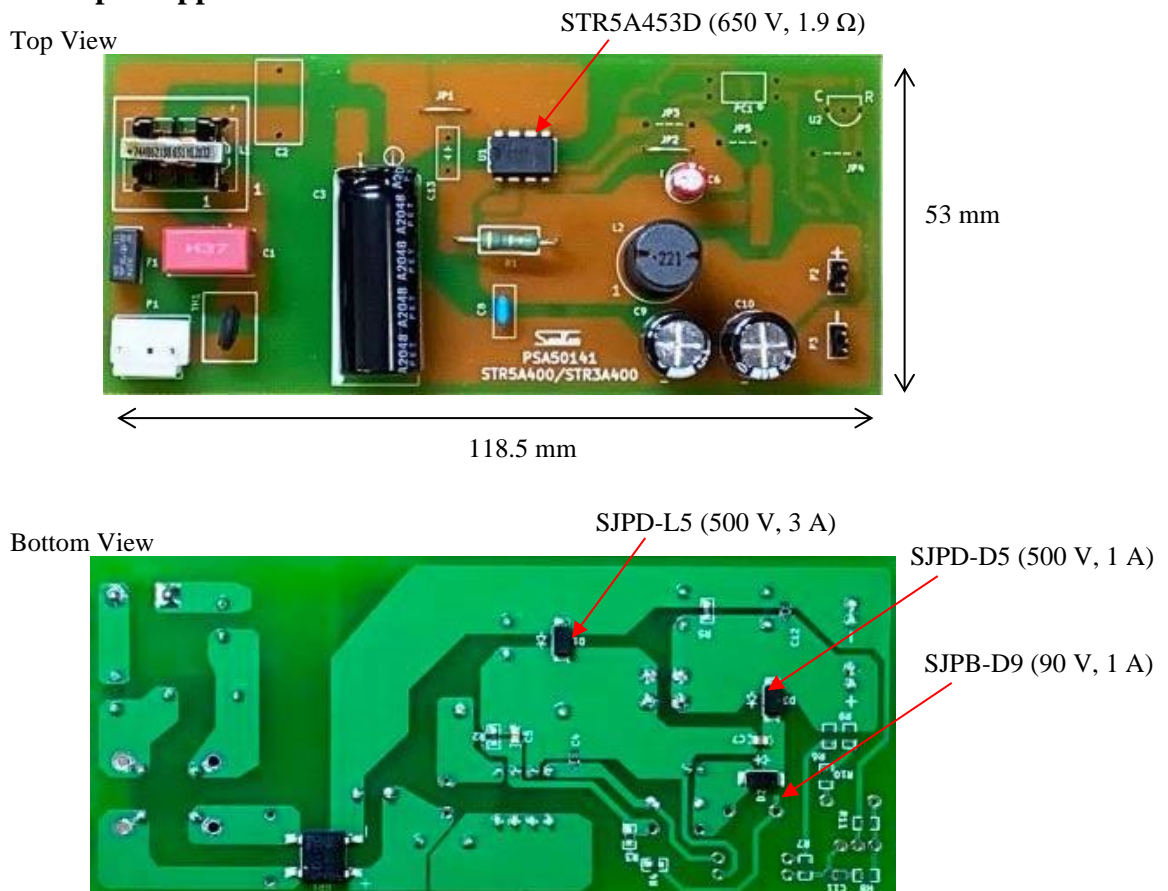

5. Design Example

5.1 Power Supply Specifications

Parameter	Symbol	Conditions	Min	Typ.	Max.	Unit
Input						
Input Voltage	V_{INAC}		85	—	265	V
Frequency	f_{LINE}		47	50/60	63	Hz
Output						
Rated Voltage	V_{NP}		13.5	15	16.5	V
Rated Current	I_{NP}		—	0.7 ⁽¹⁾	—	A
Output Ripple Voltage	V_{RIPPLE}	20 MHz bandwidth; filter added ⁽²⁾	—	36	—	mV _{P-P}
Output Power	P_{OUT}		—	10.5	—	W
Efficiency	η	Rated load, $T_A = 25\text{ }^\circ\text{C}$, 230 VAC	—	84.1	—	%
Environment						
Conduction Noise	—	$T_A = 25\text{ }^\circ\text{C}$	As per CISPR22B/EN55022B			—
Temperature						
Power Supply IC Temperature Increase ⁽³⁾	ΔT_{C-IC}	265 VAC, $I_O = 0.7\text{ A}$	—	38.8	—	$^\circ\text{C}$
Freewheeling Diode Temperature Increase ⁽⁴⁾	ΔT_{C-DI}	265 VAC, $I_O = 0.7\text{ A}$	—	39.8	—	$^\circ\text{C}$
Inductor Temperature Increase	ΔT_L	265 VAC, $I_O = 0.7\text{ A}$	—	41.4	—	$^\circ\text{C}$

5.2 Circuit Diagram

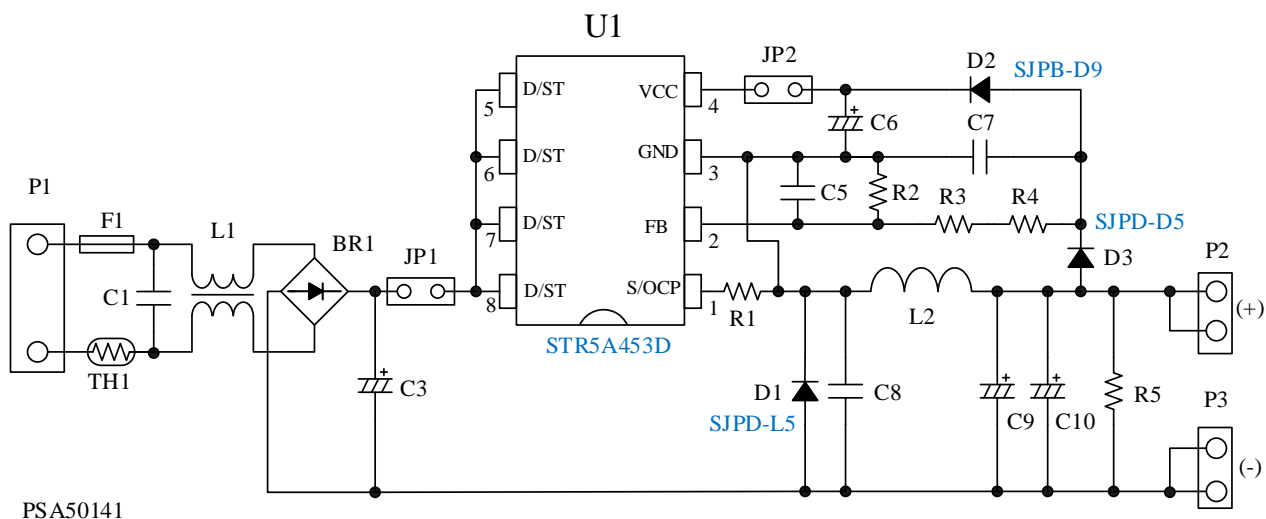

Figure 5-1. Circuit Diagram

⁽¹⁾ 0.8 A peak (for 1 second)

⁽²⁾ By connecting an electrolytic capacitor (50 V, 1 μF) and a ceramic capacitor (50 V, 0.1 μF) in parallel to the output connector of the PCB.

⁽³⁾ Refers to a case temperature of the STR5A453D.

⁽⁴⁾ Refers to a case temperature of the SJPD-L5.

5.3 Bill of Materials

Part Symbol	Part Type	Ratings	Part Number*	Manufacturer
F1	Hues	250 V, 2 A	RSTA 2 BULK	BELLEFUSE
TH1	Power thermistor	4.7 Ω , 3 A	B57153S0479M000	TDKEPCOS
C1	Film capacitor	310 VAC, 0.1 μ F	890334023023CS	Würth Electronics
C3	Electrolytic capacitor	105 $^{\circ}$ C, 400 V, 56 μ F	400QXW56MEFR12.5x30	Rubycon
C5	Chip ceramic capacitor	50 V, 470 pF, 2012	885012207084	Würth Electronics
C6	Electrolytic capacitor	105 $^{\circ}$ C, 50 V, 22 μ F	860020672011 50YXF22MEFC5x11	Würth Electronics Rubycon
C7	Chip ceramic capacitor	50 V, 2.2 μ F, 2012	UMK212BB7225KG-T	TAIYO YUDEN
C9	Electrolytic capacitor	105 $^{\circ}$ C, 25 V, 470 μ F	860080475016 UHE1E471MPD6 EKY-250E471MJ16S	Würth Electronics Nichicon Nippon Chemi-Con
C10	Electrolytic capacitor	105 $^{\circ}$ C, 25 V, 470 μ F	860080475016 UHE1E471MPD6 EKY-250E471MJ16S	Würth Electronics Nichicon Nippon Chemi-Con
C8	Ceramic capacitor	1 kV, 22 pF	RDE5C3A220J2M1H03A	Murata
BR1	Bridge rectifier diode	1000 V, 1.5 A	DF10S	ON Semiconductor
D1	Fast recovery diode	500 V, 3 A	SJPD-L5	Sanken
D2	Schottky diode	90 V, 1 A	SJPB-D9	Sanken
D3	Fast recovery diode	500 V, 1 A	SJPD-D5	Sanken
L1	CM inductor	18 mH, 0.3 A	744862180	Würth Electronics
L2	Inductor	220 μ H, 2.1 A	7447231221	Würth Electronics
R1	Resistor	1 W, 0.47 Ω	RSMF1BR47F	Akahane Electronics
R2	Chip resistor	10 k Ω , 1/8 W, 1608	CR16TR103F	Akahane Electronics
R3	Chip resistor	47 k Ω , 1/8 W, 1608	CR16TR473F	Akahane Electronics
R4	Chip resistor	4.7 k Ω , 1/8 W, 1608	CR16TR472F	Akahane Electronics
R5	Chip resistor	6.8 k Ω , 1/8 W, 1608	CR16TR682J	Akahane Electronics
U1	PWM off-line converter IC	650 V, 1.9 Ω	STR5A453D	Sanken
JP1	Jumper wire	Plated wire	$\phi = 0.6$, P = 7 mm	
JP2	Jumper wire	Plated wire	$\phi = 0.6$, P = 7 mm	
P1	Connector	250 V	B2P3-VH	JST
P2	Connector	50 V	61300211121	Würth Electronics
P3	Connector	50 V	61300211121	Würth Electronics
—	PCB		PSA50141	Sanken

* When multiple parts are listed, any one of them is used.

5.4 Pattern Layout Example

The design example uses only the parts listed in the circuit diagram and the bill of materials.
 PCB dimensions: 118.5 mm × 53.0 mm

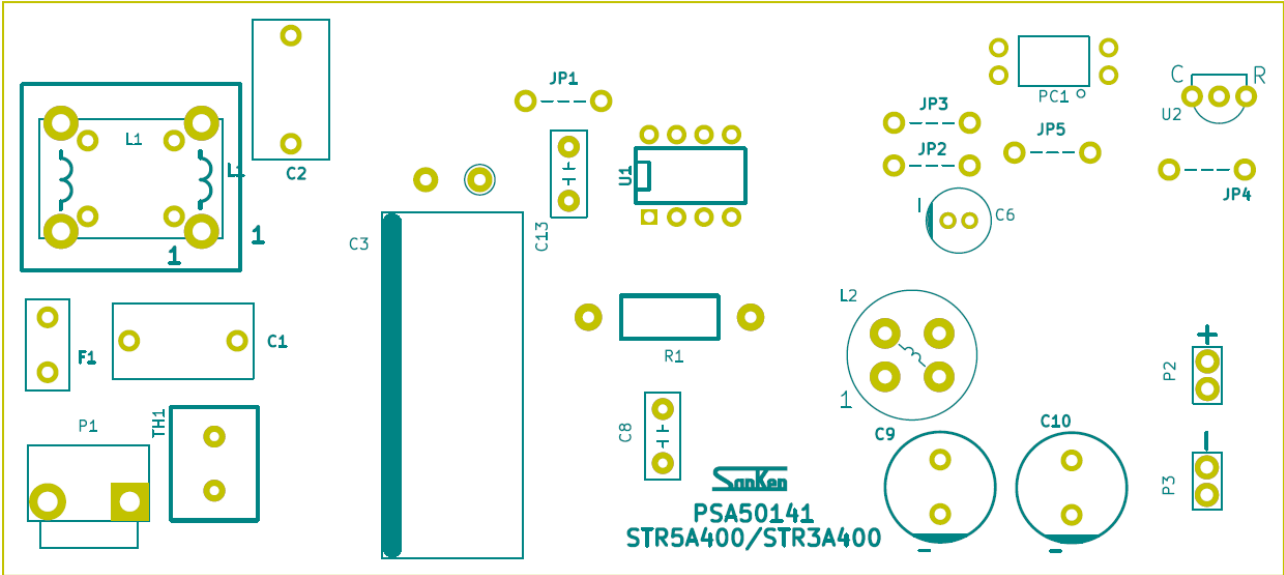

(a) Top View

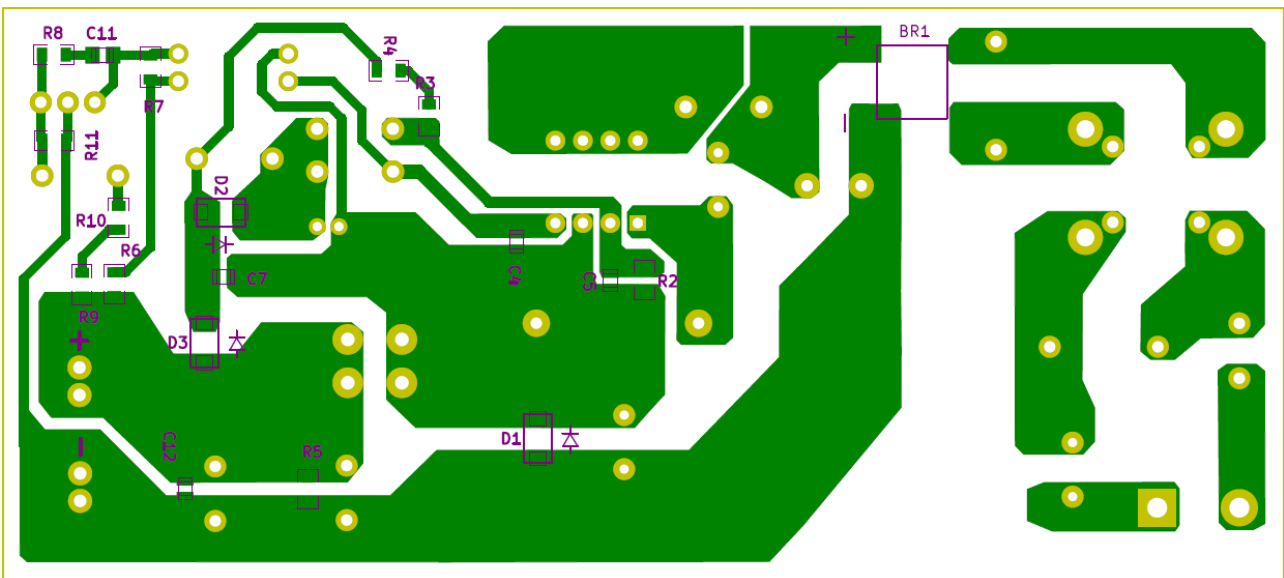

(b) Bottom View

Figure 5-2. Pattern Layout Example

6. Design Example: Basic Operations

The connector P1 is connected to an AC power supply. When an AC voltage is applied, the AC input voltage is full-wave rectified via the input filter and the bridge rectifier diode BR1. The rectified voltage is then smoothed to a DC voltage by the electrolytic capacitor C3.

The input filter part includes the following components: C1 for a normal-mode noise filter; L1 for a common-mode noise filter; the power thermistor TH1 for an inrush current limiter.

When a voltage is applied to the D/ST pin of the power supply IC (U1: STR5A453D), the internal startup circuit turns on. Consequently, a startup current flowing out of the VCC pin charges the electrolytic capacitor C6. When the VCC pin voltage increases to the IC operation start voltage, the IC control circuit starts to operate. Then, the internal power MOSFET starts its PWM switching operation. After the IC operation starts, the startup circuit turns off and the VCC pin power is supplied from the output via the fast recovery diode D3 and Schottky diode D2.

During a power MOSFET turn-on period, L2 stores energy with the I_{ON} current path (Figure 6-1) and charges the output electrolytic capacitors C9 and C10. In this design example, low-ESR capacitors should be used for C9 and C10.

During a power MOSFET turn-off period, the energy stored in L2 generates back EMF, and the freewheeling diode D1 is then forward-biased and turned on. This allows currents to flow through the I_{OFF} current path (Figure 6-1). In the manner explained above, the internal power MOSFET repeats turning on and off to increase the output voltage to its target voltage level. A signal produced by the output voltage divided by the resistors R2 to R4 is input to the FB pin. With this signal, the power supply IC controls the duty cycle of the internal MOSFET to regulate output voltages to be constant. The bleeder resistor R5 is connected in parallel to C9 and C10 for suppressing an increase in the output voltage at light load.

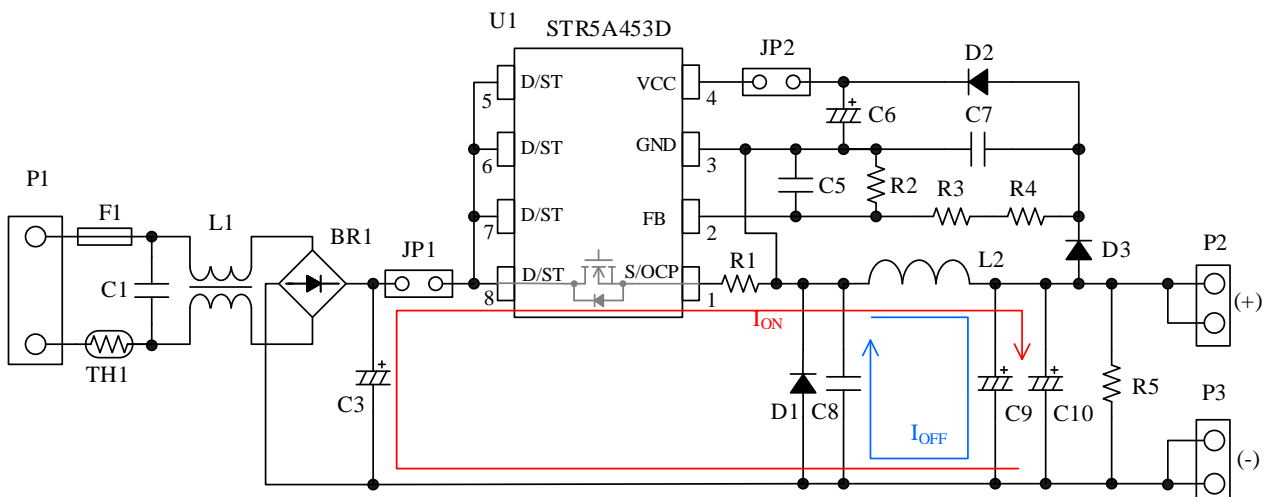

Figure 6-1. Circuit Diagram

7. Designing the Power Supply

7.1 Setting an Output Voltage

The equation below defines the relation between the output voltage, V_{OUT} , and the resistors R2 to R4:

$$R3 + R4 = \left(\frac{|V_{OUT}| - V_{FD3} + V_{FD1}}{V_{FB(REF)}} - 1 \right) \times R2. \quad (7-1)$$

Where:

V_{FD1} is the forward voltage of D1,

V_{FD3} is the forward voltage of D3, and

$V_{FB(REF)}$ is the reference voltage of the FB pin.

Based on Equation (7-1), when $V_{OUT} = 15 \text{ V}$, $V_{FD1} = 0.9 \text{ V}$, $V_{FD3} = 0.5 \text{ V}$, $V_{FB(REF)} = 2.5 \text{ V}$, example setting values for the resistors R2 to R4 are as follows:

R2 = 10 k Ω

R3 = 47 k Ω

R4 = 4.7 k Ω

7.2 Calculating an Inductance

7.2.1 PWM Switching Modes

As Figure 7-1 shows, the PWM control has three operation modes: the continuous conduction mode (CCM), the critical conduction mode (CRM), and the discontinuous conduction mode (DCM).

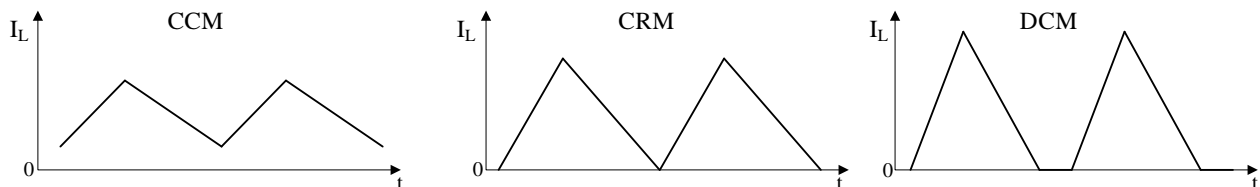

Figure 7-1. PWM Switching Modes

The CCM is a mode that reduces conduction losses in a power MOSFET but has a tendency to be noise-prone and switching-loss increasing because the power MOSFET turns on while a current flows through an inductor. Up to the level where output load is about 15 W (15 V, 1 A), a ratio of switching losses predominates over a ratio of conduction losses. This tendency appears prominently in the condition where an input voltage is high and a direct current is superpositioned (see Table 7-1, and Figure 7-2 to Figure 7-5).

In the CRM and DCM operations, the power MOSFET turns on even when an inductor current is zero, thus resulting in lower noise and switching losses.

Taking reduced power MOSFET losses and better circuit efficiency into account, set the design example to operate in the DCM.

Table 7-1. Power MOSFET Losses

Parameter	Losses in CCM Operation (W)		Losses in CRM Operation (W)	
	85 VAC	265 VAC	85 VAC	265 VAC
Conduction Loss	0.56	0.12	0.51	0.11
Turn-on Loss	0.08	0.47	0.05	0.29
Turn-off Loss	0.03	0.14	0.03	0.13
Total	0.67	0.73	0.59	0.53

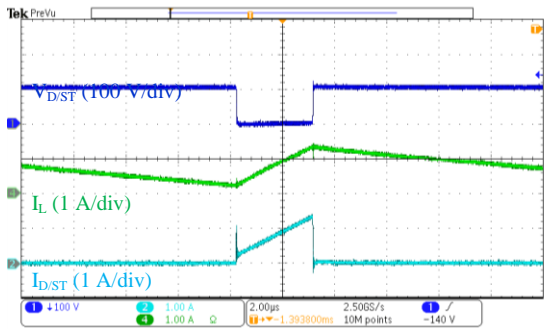

Figure 7-2. Operational Waveforms in CCM ($V_{IN} = 85 \text{ VAC}$)

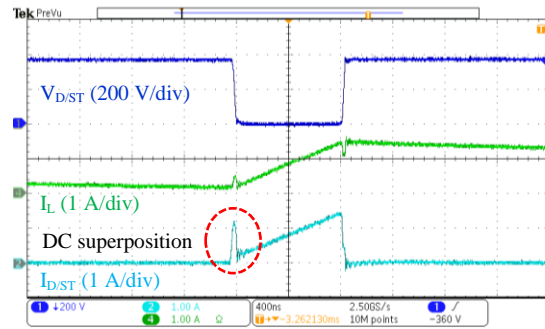

Figure 7-3. Operational Waveforms in CCM ($V_{IN} = 265 \text{ VAC}$)

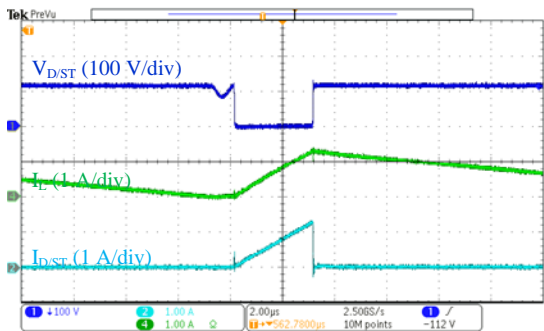

Figure 7-4. Operational Waveforms in CRM ($V_{IN} = 85 \text{ VAC}$)

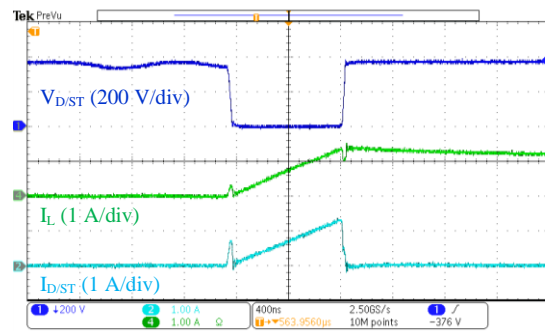

Figure 7-5. Operational Waveforms in CRM ($V_{IN} = 265 \text{ VAC}$)

7.2.2 Parameter Definitions

When you set the output voltage, V_{OUT} , to ≥ 25.7 V, the STR5A453D requires the Zener diode DZ1 to be connected in series with D1, as in Figure 7-6. Be sure to perform operation checking so that the VCC pin voltage will not decrease to the startup current bias threshold voltage.

Assuming that a duty cycle settable during normal operation is up to 65%, V_{OUT} should be determined so that it can satisfy Equation (7-2), below. The design example can step down V_{OUT} to $\leq 65\%$ of the the input voltage.

$$V_{CC(OFF)}(\text{max.}) < V_{OUT} - (V_{DZ1} + V_{DF2} + V_{DF3}) + V_{DF1} < V_{CC(OVP)}(\text{min.}). \quad (7-2)$$

Where:

$V_{CC(OVP)}$ is the minimum OVP threshold voltage (27.5 V), and
 V_{DZ1} is the Zener diode of DZ1.

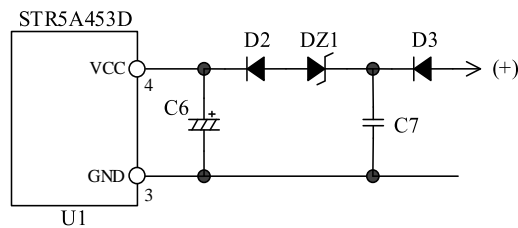

Figure 7-6. Circuit Configuration with Increased Output Voltage, V_{OUT}

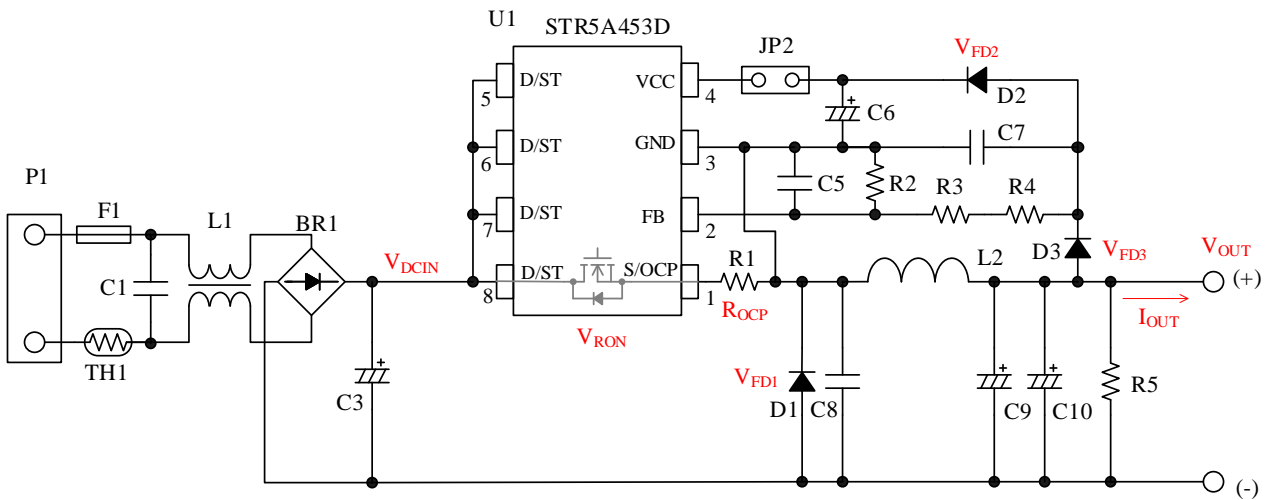

Figure 7-7. Circuit Diagram

Table 7-2 explains the definitions for the symbols used as circuit parameters in Figure 7-7.

Table 7-2. Circuit Parameters

Symbol	Description
V_{DCIN_MIN}	C3 DC input voltage lower limit
V_{DCIN_MAX}	C3 DC input voltage upper limit
V_{OUT}	Output voltage
I_{OUT}	Output current
V_{RON}	Internal power MOSFET on-voltage: $V_{RON} = \text{drain current} \times R_{DS(ON)}$
V_{FD3}	D3 forward voltage
V_{FD2}	D2 forward voltage
V_{FD1}	D1 forward voltage
V_{DZ1}	DZ1 Zener voltage (when $V_{OUT} \geq 27.5$ V, add a Zener diode or regulator; pay attention to losses)
R_{OCP}	Current detection resistance between the S/OCP and GND pins

Table 7-3 lists the characteristic parameters dependent on the power supply IC. For the values specified for the power supply IC, refer to the data sheet.

Table 7-3. Characteristic Parameters

Symbol	Description	Value Specified for STR3A453D
D_{ON_MAX}	Maximum settable duty cycle in normal operation	0.5
V_{ST_MAX}	Maximum startup circuit operating voltage, $V_{ST(ON)}$	37 V
$V_{DC(MAX)}$	Maximum DC input voltage	400 V (Recommended)
$V_{CC(OVP)_MIN}$	Minimum OVP threshold voltage, $V_{CC(OVP)}$	27.5 V
I_{DLIM}	$< IDPEAK \times 0.9$ (i.e., a derating of 90%)	< 4.68 A
f_{TYP}	Average oscillation frequency, $f_{OSC(AVG)}$	60 kHz
$V_{OCP(L)_MIN}$	Minimum OCP threshold voltage at zero duty cycle, $V_{OCP(L)}$	0.640 V
$V_{OCP(H)_MIN}$	Minimum OCP threshold voltage, $V_{OCP(H)}$	0.74 V
$V_{OCP(H)_TYP}$	Typical OCP threshold voltage, $V_{OCP(H)}$	0.83 V
$V_{OCP(H)_MAX}$	Maximum OCP threshold voltage, $V_{OCP(H)}$	0.92 V
DPC	Typical OCP compensation coefficient	15.8 mV/ μ s

Figure 7-8 shows the inductor current waveforms in the critical conduction mode (CRM) and the discontinuous conduction mode (DCM), respectively. Table 7-4 lists the definitions for the symbols used in Figure 7-8.

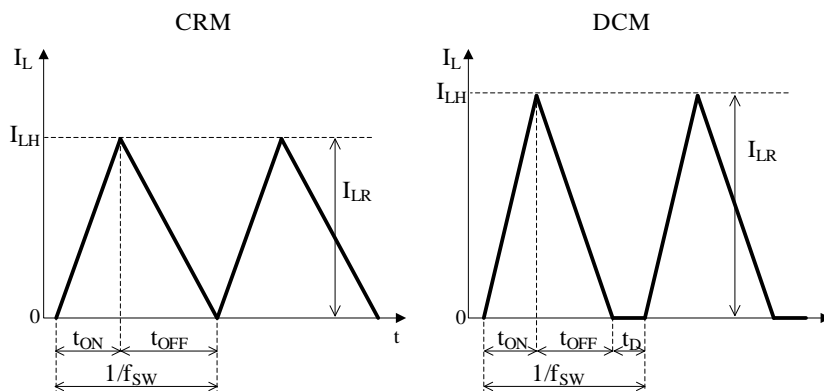

Figure 7-8. Operation Modes for PWM Control

Table 7-4. Inductor Current Waveform Parameters

Symbol	Description
f_{sw}	Switching frequency
t_{ON}	On-time
t_{OFF}	Off-time
t_D	Discontinuous time
I_{LH}	Inductor current upper limit
I_{LR}	Inductor ripple current

Table 7-5 provides the input/output conditions defined for the buck converter.

Table 7-5. Buck Converter Input/Output Conditions

Parameter	Conditions	
	Min.	Max.
V_{DCIN}	Will be the higher of the below: $\geq V_{ST_MAX}$ $> 2.0 \times V_{OUT} + 1.5 \times V_{FD1} + V_{RON}$	$\leq V_{DC(MAX)}$
V_{OUT}	$> V_{CC_MIN} + V_{DZ1} - V_{FD1} + V_{FD2} + V_{FD3}$	$< 0.5 \times (V_{DCIN_MIN} - V_{RON} - V_{FD1})$
I_{OUT}	—	$< 0.5 \times I_{DLIM}$ (Depends on the OCP setting or heat generated by the IC's on-resistance)
V_{DZ1}	Will be the higher of the below: ≥ 0 $> V_{OUT} + V_{FD1} - (V_{FD2} + V_{FD3} + V_{CC(OVP)_MIN})$	$< V_{OUT} + V_{FD1} - (V_{FD2} + V_{FD3} + V_{CC(OFF)_MAX})$
R_{OCP}	$\geq \frac{V_{OCP(H)_MAX}}{I_{DLIM}}$	—

7.2.3 Calculating an Inductance

The design example should operate in the discontinuous conduction mode (DCM), with consideration given to reduction in power MOSFET losses and improvement in circuit efficiency. Firstly, to select your inductor, calculate an inductance, L_{CRM} , in the critical conduction mode (CRM). Then, obtain individual parameters based on the inductance of the inductor you selected.

We now start with calculating the inductance, L_{CRM} , in the CRM operation. Note that the duty cycle, D_{ON} , should be set within the range defined as:

$$D_{ON} = \frac{V_{OUT} + V_{FD1}}{V_{DCIN_MIN} - V_{RON} + V_{FD1}} < 0.5. \quad (7-3)$$

The parameters for the inductor current in the CRM operation can be obtained as follows (see Figure 7-8, the operational waveforms in CRM):

$$I_{LH} = 2 \times I_{OUT}, \text{ and}$$

$$I_{LR} = I_{LH}.$$

The equation below defines I_{LH} :

$$I_{LH} = \frac{V_{OCP(H)}}{R_{OCP}}, \quad (7-4)$$

where $V_{OCP(H)}$ is the OCP threshold voltage of the STR5A453D, and R_{OCP} is the resistance of the current-sensing resistor R1.

Then, the inductance, L_{CRM} , in the CRM operation can be determined as:

$$L_{CRM} = \frac{(V_{DCIN_MIN} - V_{OUT} - V_{RON}) \times D_{ON}}{f_{TYP} \times I_{LH}}. \quad (7-5)$$

Finally, to prevent the design example from operating in the CCM, select the inductance, L_{USER} , of the inductor to be used from the range defined below, with variations and other factors taken into account:

$$L_{USER} < L_{CRM} \times 0.9. \quad (7-6)$$

Using Equation (7-5), we found $L_{CRM} \approx 164 \mu\text{H}$ for the design example when $V_{DCIN_MIN} = 120 \text{ V}$, $V_{OUT} = 15 \text{ V}$, $I_{LH} = 1.4 \text{ A}$, $V_{RON} = 1.9 \Omega \times 1.4 \text{ A} \approx 2.66 \text{ V}$, $D_{ON} = 0.135$, and $f_{TYP} = 60 \text{ kHz}$. Hence, a target inductance value for the DCM operation is $L_{USER} \approx 148 \mu\text{H}$. According to this target value, select your inductor from the ones available in the market.

Note that the inductor you selected should have an optimal inductance with efficiency and losses taken into account (see Section 7.2.4).

For the inductor you selected, calculate the individual parameters for the buck converter.

• Inductor Current

The equation below defines the inductor current upper limit, I_{LH} :

$$I_{LH} = \sqrt{\frac{2 \times I_{OUT} \times (V_{DCIN_MIN} - V_{OUT}) \times V_{OUT}}{f_{TYP} \times L_{CRM} \times 0.9 \times V_{DCIN_MIN}}} \quad (7-7)$$

• On-time

The power MOSFET on-time, t_{ON} , can be obtained as follows:

$$t_{ON} = \frac{L_{CRM} \times 0.9 \times I_{LH}}{(V_{DCIN_MIN} - V_{OUT} - V_{RON})} \quad (7-8)$$

• Current-sensing Resistor R1

The STR5A453D has the OCP input compensation function that compensates the OCP threshold voltage according to an on-time. This involves calculating an upper limit of the current detection resistance, $R_{OCP(H)_TMP}$, for a compensated OCP threshold value. The minimum compensated OCP threshold value, $V_{OCP(H)_MIN}'$, is determined as follows: the minimum $V_{OCP(H)}$ of 0.74 V when $t_{ON} \geq 6 \mu s$; the calculation result of Equation (7-9) when $t_{ON} < 6 \mu s$.

$$V_{OCP(H)_MIN}' = V_{OCP(L)_MIN} + DPC \times t_{ON} \quad (7-9)$$

Where:

- $V_{OCP(L)_MIN}$ is the minimum OCP threshold voltage at zero duty cycle (0.640 V),
- DPC is the OCP compensation coefficient (15.8 mV/ μs), and
- t_{ON} is the power MOSFET on-time (μs).

Be sure to set the current detection resistance to a value such that the OCP does not get activated during normal operation. By substituting the results from Equations (7-7) to (7-9), you can obtain an upper limit of the current detection resistance, $R_{OCP(H)_TMP}$, with the equation below:

$$R_{OCP(H)_TMP} = \frac{V_{OCP(H)_MIN}'}{I_{LH}} \quad (7-10)$$

The current detection resistance, R_{OCP} , should have a sufficient margin to deal with variations and other factors so that the output current you have set can be supplied. In a condition where the OCP threshold voltage, $V_{OCP(H)}$, is at its maximum value, I_{DLIM} should also have a sufficient margin to the absolute maximum rating, I_{DPEAK} , so that the IC's maximum switching current does not exceed I_{DPEAK} .

$$R_{OCP} < R_{OCP(H)_TMP} \quad (7-11)$$

$$I_{DLIM} > \frac{V_{OCP(H)_MAX}}{R_{OCP}}$$

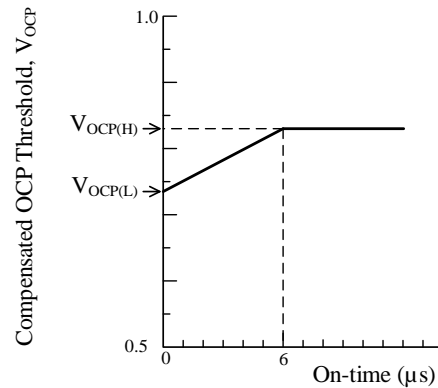

Figure 7-9. On-time vs. Compensated V_{OCP}

7.2.4 Considering Optimization

The STR5A453D has the green mode that can reduce its frequency according to loads. This allows the design example to operate in the discontinuous conduction mode (DCM) at a rated load by increasing the L2 inductance, L_{USER} , and the overcurrent detection resistance, R_{OCP} , even with a peak inductor current decreased.

Figure 7-10 to Figure 7-12 are the comparison data (reference only) of L_{USER} and R_{OCP} measured under different conditions. From these results, we selected $L_{USER} = 220 \mu\text{H}$ and $R_{OCP} = 0.47 \Omega$ for the design example.

We also set the design example to have a switching frequency of about 40 kHz to 50 kHz so that it will not operate in the continuous conduction mode (CCM) at the rated load where $V_{IN} = 265 \text{ VAC}$. If the rated load is too low to the peak load actually obtained, a switching frequency at the rated load may substantially decrease. However, the circuit in this condition exerts little influence upon power MOSFET losses and efficiencies due to a low effective current.

Table 7-6 lists the reference inductances of the buck converter using the STR5A453D. Be sure to calculate an inductance based on the actual specifications (see Section 7.2.3), then determine constants after checking actual operations.

Note that inductor current values, IC losses, efficiencies vary among load conditions, an inductance of the inductor to be used, and an overcurrent detection resistance. Therefore, be sure to verify these parameters by checking actual operations. Furthermore, make certain that a maximum rated load can be ensured, and no problems exist in the electrical characteristics and absolute maximum ratings defined for the IC used.

Table 7-6. Reference Inductances

Rated Load	Reference Inductance
15 V, 0.7 A	100 μH to 220 μH
15 V, 0.4 A	180 μH to 330 μH

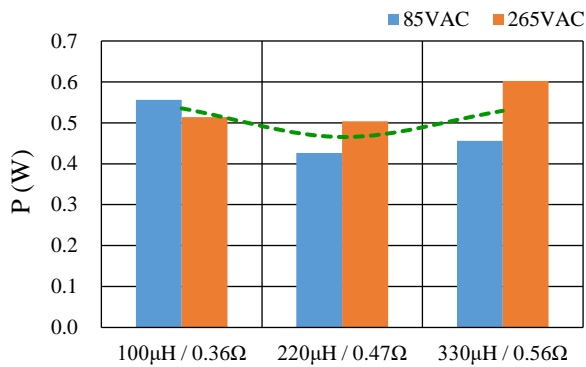

Figure 7-10. Reference Power MOSFET Losses, P (STR5A453D: 15 V, 0.7 A)

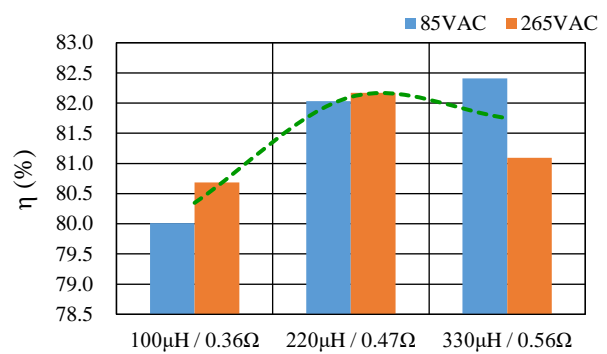

Figure 7-11. Reference Efficiencies, η (STR5A453D: 15 V, 0.7 A)

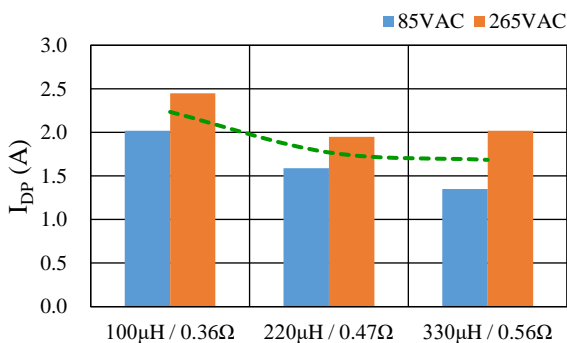

Figure 7-12. Reference Peak Drain Currents, I_{DP} (STR5A453D: 15 V, 0.7 A)

7.3 Selecting the Bridge Rectifier Diode BR1

For the bridge rectifier diode BR1, select the one that has voltage and current ratings with sufficient margin to the upper limits of AC input voltage and current.

When the upper limit of an input voltage is 265 VAC, the voltage to be applied to BR1 is as follows: $V_p = 265 \text{ (VAC)} \times \sqrt{2} \approx 375 \text{ (VDC)}$. When a derating of $\geq 80\%$ is applied to the BR1 breakdown voltage, BR1 requires a breakdown voltage of $\geq 500 \text{ V}$.

The equation below defines the input current, I_{IN} :

$$I_{IN} = \frac{P_{OUT}}{V_{INAC(MIN)} \times \eta \times PF} \quad (7-12)$$

Where:

- P_{OUT} is the output power,
- $V_{INAC(MIN)}$ is the lower limit of the AC input voltage,
- η is the efficiency, and
- PF is the power factor.

From Equation (7-12), when $P_{OUT} = 10.5 \text{ W}$, $V_{INAC(MIN)} = 85 \text{ VAC}$, $\eta = 0.84$, $PF = 0.6$, hence $I_{IN} \approx 245 \text{ mA}$. When a derating of $\geq 80\%$ is applied to the BR1 rated current, BR1 requires a rated current of $\geq 306 \text{ mA}$.

For the design example, we selected the bridge rectifier diode with a breakdown voltage of 1000 V and a rated current of 1.5 A, from the ones available in the market.

7.4 Selecting the Freewheeling Diode D1, VCC Power Supply Diode D3, and Feedback Diode D3

For D1 and D3, select a fast recovery diode (FRD) with a short recovery time because switching currents flow through them. Any of the diodes should have voltage and current ratings with sufficient margin to the upper limits of AC input voltage and current, and to peak currents that flow through the diodes. When the upper limit of an input voltage is 265 VAC, the voltage to be applied to the diodes is as follows: $V_p = 265 \text{ (VAC)} \times \sqrt{2} \approx 375 \text{ (VDC)}$. Note that a surge voltage during switching operation is also an important parameter to take into account. When a derating of $\geq 80\%$ is applied to the breakdown voltages of the diodes, each diode requires a breakdown voltage of $\geq 500 \text{ V}$. The diodes should have sufficient margins as follows: D1 to the peak current, I_{LP} , that flows through the inductor L2; D2 to the circuit current during power supply IC operation; D3 to the current value that provides enough circuit and feedback currents during power supply IC operation.

For D2, use a Schottky diode (SBD) for minimizing the effect of the forward voltage, V_F , to output voltages. Moreover, select the breakdown voltage of D2 with setting a derating of $\geq 80\%$ to the maximum OVP threshold voltage, $V_{CC(OVP)} = 31.3 \text{ V}$.

For the design example, I_{LP} was approximately 1.6 A based on the operational waveforms in actual normal operation (Figure 9-5 to Figure 9-8). Given that a circuit current of up to 3 mA and a feedback current of up to 2.4 μA will run through while the STR5A453D operates, we selected the diodes with the following ratings from the ones available in the market:

- Freewheeling diode D1: FRD, 500 V, 3 A (SJPD-L5)
- VCC power supply diode D2: SBD, 90 V, 1 A (SJPB-D9)
- Feedback diode D3: FRD, 500 V, 1 A (SJPB-D9)

7.5 Selecting the Bleeder Resistor R5

For suppressing an increase in the output voltage at light load, the bleeder resistor R5 is connected in parallel to C9 and C10. Select a resistance of R5 so that regulation characteristics can fall within a target range of $\pm 10\%$ to an output voltage of 15.0 V while checking actual operations. Note that the higher the regulation characteristics improve, the more the reactive power increases; therefore, be sure to select a well-balanced resistance value. For the design example, we selected the resistor of 6.8 k Ω .

8. Performance Data

All the performance data contained in this document were measured at a room temperature, an AC line frequency of 50 Hz, and a load of 10.5 W (15 V, 0.7 A).

8.1 Efficiency

Figure 8-1 shows the characteristics of power supply efficiency vs. input voltage; Figure 8-2 shows the characteristics of power supply efficiency vs. output power.

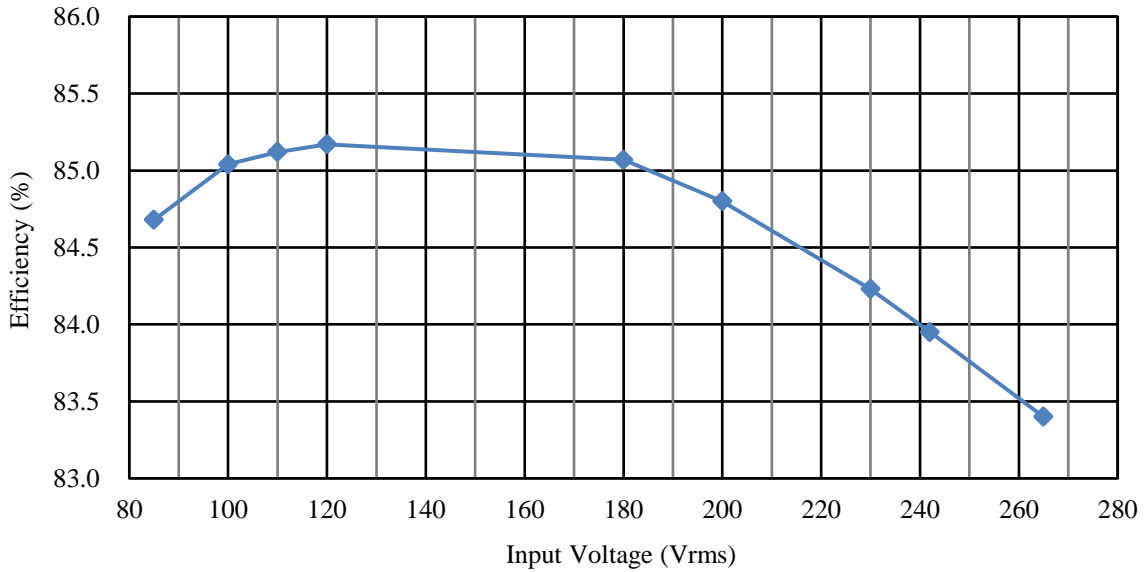

Figure 8-1. Efficiency vs. Input Voltage

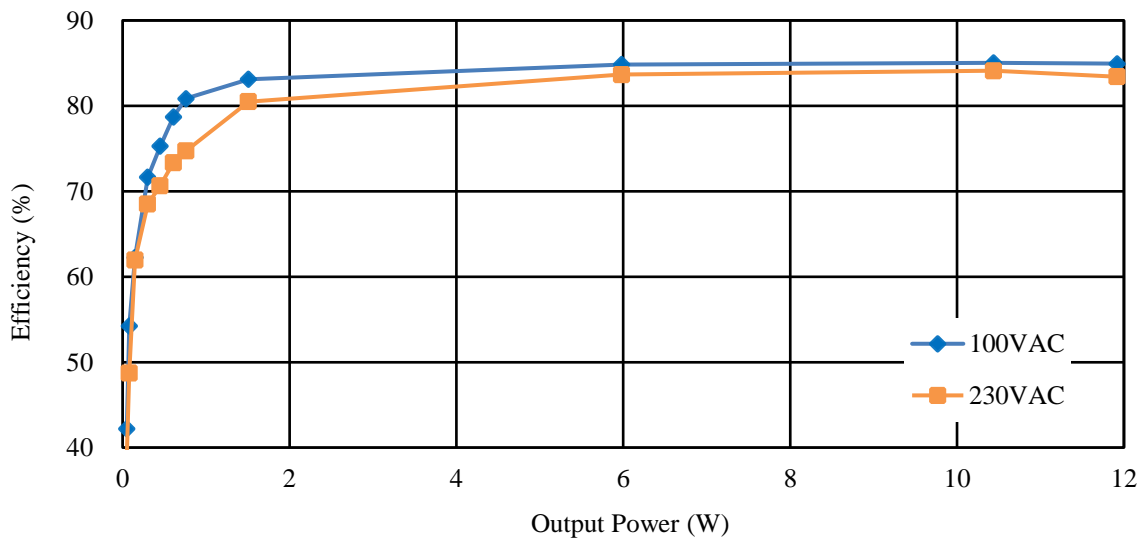

Figure 8-2. Efficiency vs. Output Power

8.2 Standby Power

Table 8-1. Input Power at No Load

Input Voltage	Input Power
100 VAC	54.1 mW
230 VAC	62.3 mW

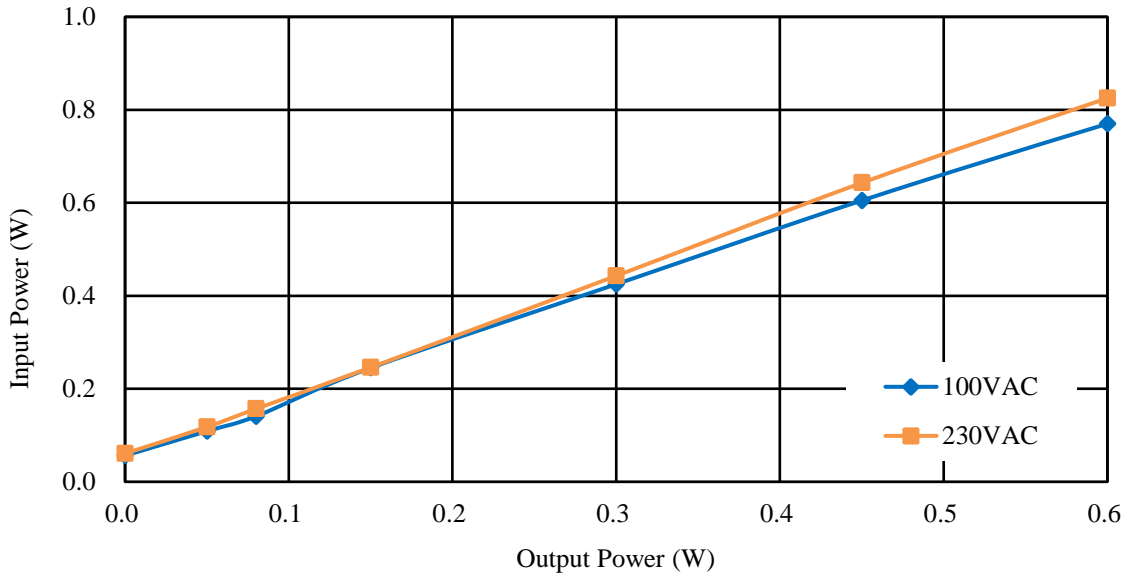

Figure 8-3. Input Power vs. Output Power

8.3 Line Regulation

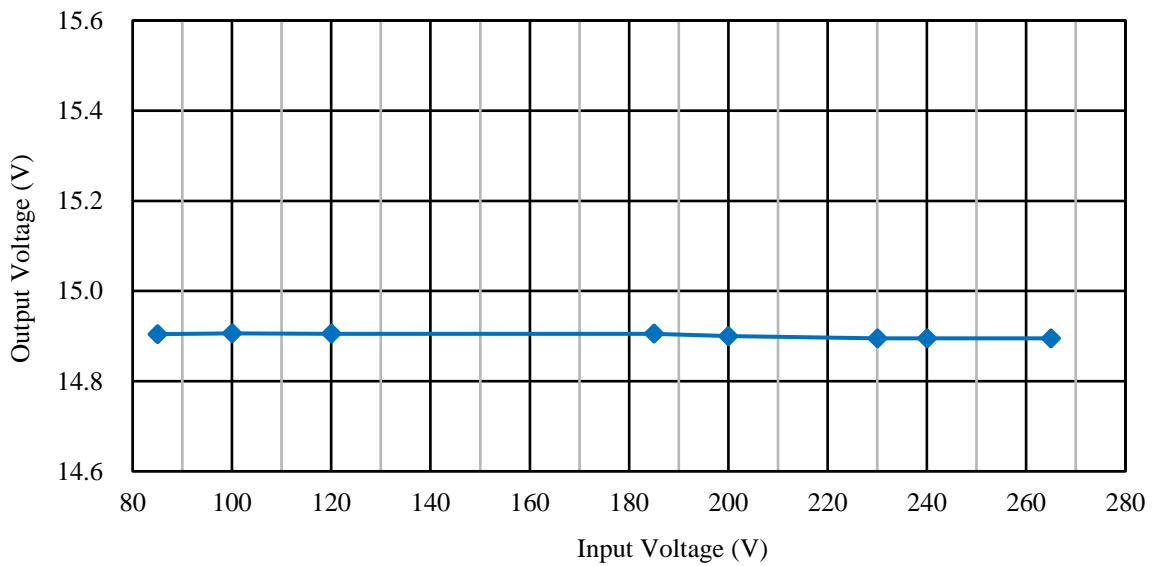

Figure 8-4. Output Voltage vs. Input Voltage

8.4 Load Regulation

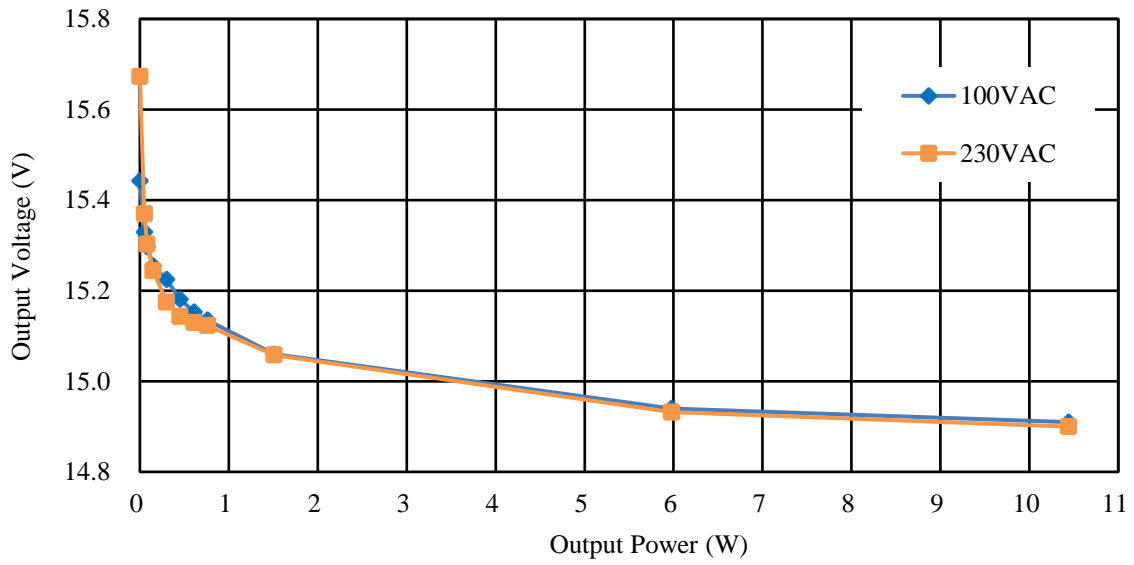

Figure 8-5. Output Voltage vs. Output Power

9. Operation Check

All the performance data contained in this document were measured at a room temperature and an AC line frequency of 50 Hz.

The maximum continuous load is 10.5 W (15 V, 0.7 A), and the maximum instantaneous current is 0.8 A (≤ 1 s).

For more details on the power supply IC (STR5A453D) such as electrical characteristics and operational descriptions, refer to the data sheet.

9.1 Startup Operation

9.1.1 Power Supply IC Switching Operation

When the soft start function is activated at power-on, the D/ST pin current, $I_{D/ST}$, of the power supply IC slowly increases. When the voltage across the current-sensing resistor R1 reaches the OCP threshold voltage of the power supply IC, the overcurrent protection (OCP) is activated to limit the output power.

Figure 9-1 shows the waveform of the D/ST pin voltage, $V_{D/ST}$. The pulsating part of the $V_{D/ST}$ waveform indicates a full-wave rectified input ripple component. The D/ST pin current, $I_{D/ST}$, is and remains limited by the OCP during the period until the output voltage becomes constant. When the output voltage becomes constant after the limitation, $I_{D/ST}$ decreases.

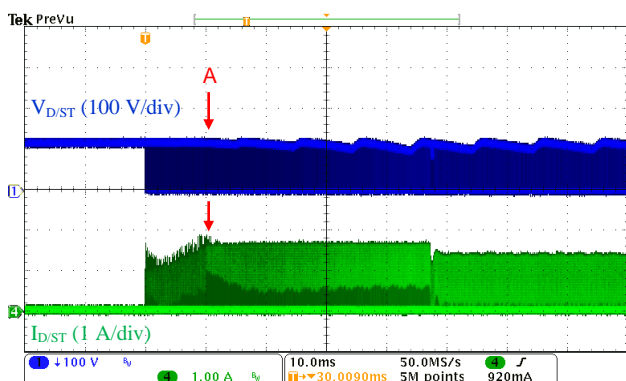

Figure 9-1. Operational Waveforms at Startup
($V_{IN} = 85$ VAC, $I_O = 0.7$ A)

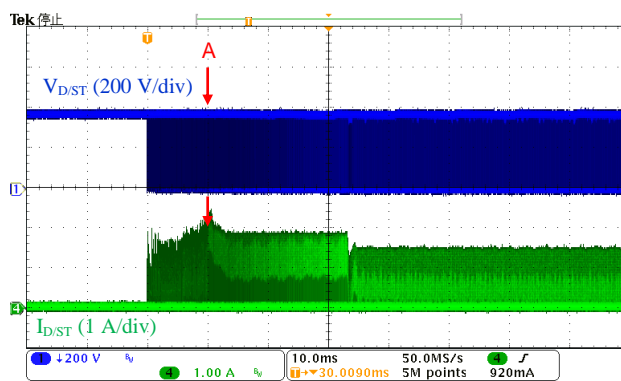

Figure 9-2. Operational Waveforms at Startup
($V_{IN} = 265$ VAC, $I_O = 0.7$ A)

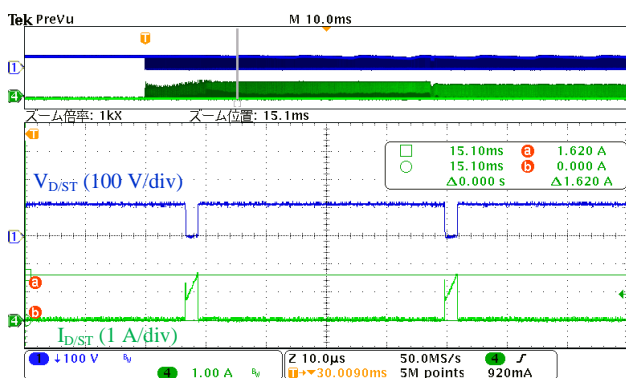

Figure 9-3. Operational Waveforms at Startup
(Expanded Scale of A in Figure 9-1)

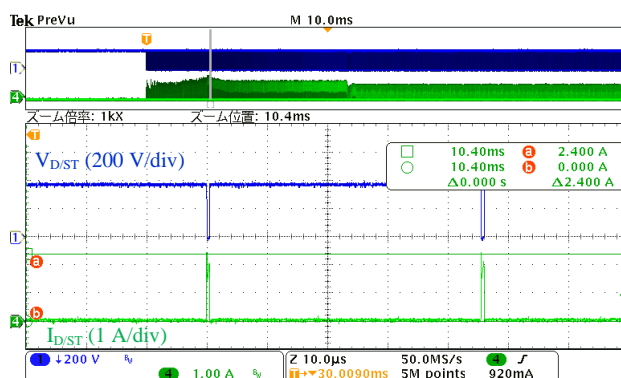

Figure 9-4. Operational Waveforms at Startup
(Expanded Scale of A in Figure 9-2)

9.1.2 Output Voltage

When the soft start function is activated at power-on, the output voltage, V_{OUT} , gradually decreases. After V_{OUT} reaches its target voltage, V_{OUT} has no overshoot and shifts to the normal operation state within the power supply specifications.

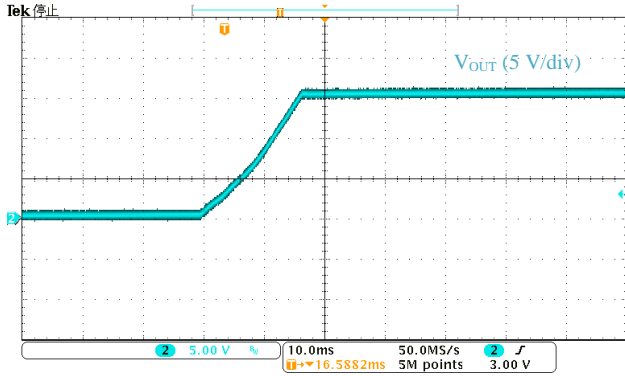

Figure 9-5. Output Voltage Waveform at Startup ($V_{IN} = 85 \text{ VAC}$, $I_O = 0 \text{ A}$)

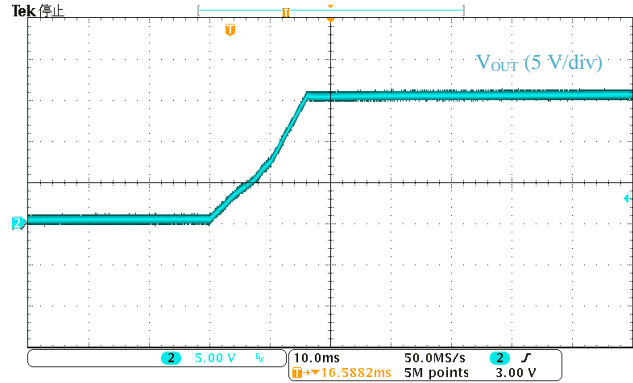

Figure 9-6. Output Voltage Waveform at Startup ($V_{IN} = 265 \text{ VAC}$, $I_O = 0 \text{ A}$)

9.2 Power Supply IC Switching Operation

The STR5A453D automatically shifts its operation modes according to loads and enhances efficiency in all load ranges. Therefore, the power supply IC monitors not only its normal operation but also the operations in all load ranges.

9.2.1 Normal Operation

Figure 9-7 to Figure 9-10 provide the waveforms in normal operation. These waveforms show that the frequencies in normal operation are approximately 47 kHz, which are within the frequencies in the green mode, under any of the input voltages. Each drain peak current setting has a margin to its overcurrent operating point.

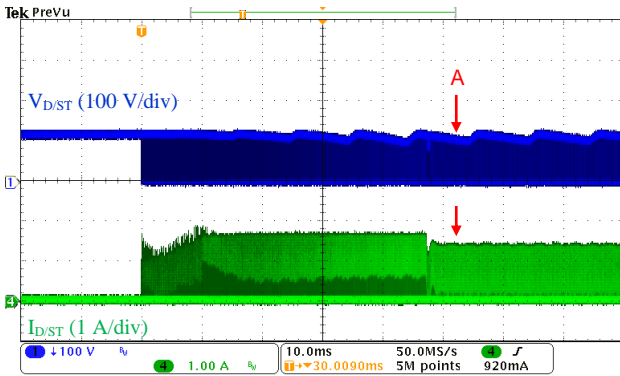

Figure 9-7. Operational Waveforms in Normal Operation ($V_{IN} = 85 \text{ VAC}$, $I_O = 0.7 \text{ A}$)

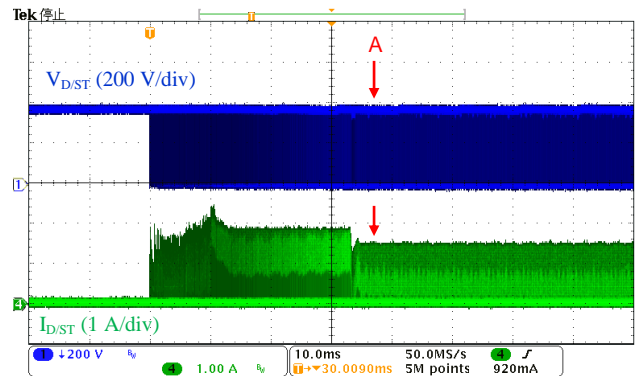

Figure 9-8. Operational Waveforms in Normal Operation ($V_{IN} = 265 \text{ VAC}$, $I_O = 0.7 \text{ A}$)

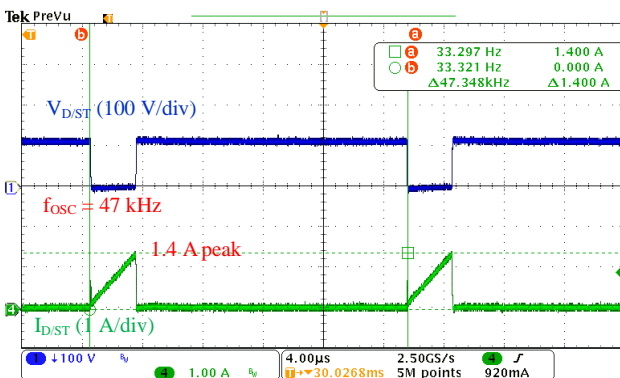

Figure 9-9. Operational Waveforms in Normal Operation (Expanded Scale of A in Figure 9-7)

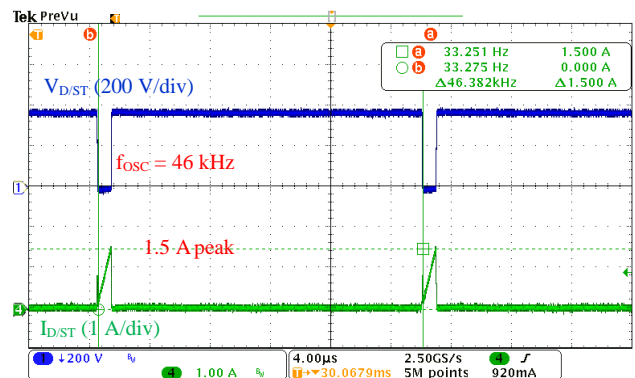

Figure 9-10. Operational Waveforms in Normal Operation (Expanded Scale of A in Figure 9-8)

9.2.2 Light-load Operation (Green Mode)

In light-load operation, the power supply IC enters the green mode and reduces its oscillation frequency according to loads.

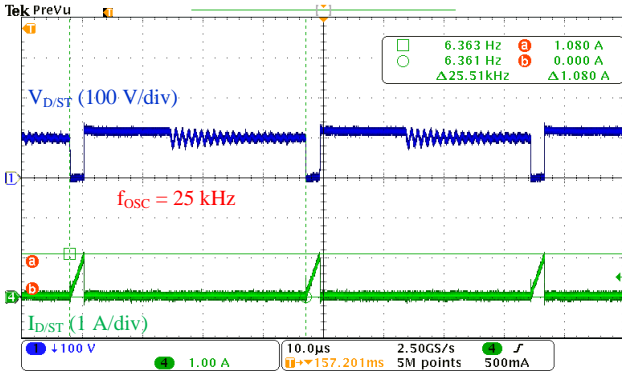

Figure 9-11. Operational Waveforms at Light Load ($V_{IN} = 85 \text{ VAC}$, $I_O = 0.2 \text{ A}$)

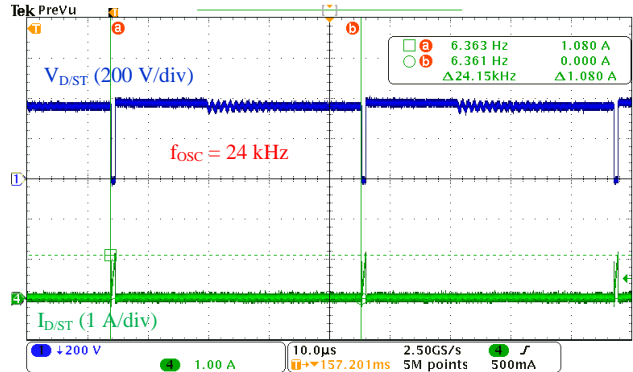

Figure 9-12. Operational Waveforms at Light Load ($V_{IN} = 265 \text{ VAC}$, $I_O = 0.2 \text{ A}$)

9.2.3 No-load Operation (Burst Oscillation)

In no-load operation, the power supply IC enters the burst oscillation operation. The burst oscillation period, T_{STBOP} , of the design example is defined as follows: 0.35 ms when $V_{IN} = 85 \text{ VAC}$, and 1.1 ms when $V_{IN} = 265 \text{ VAC}$. The burst oscillation period changes according to loads.

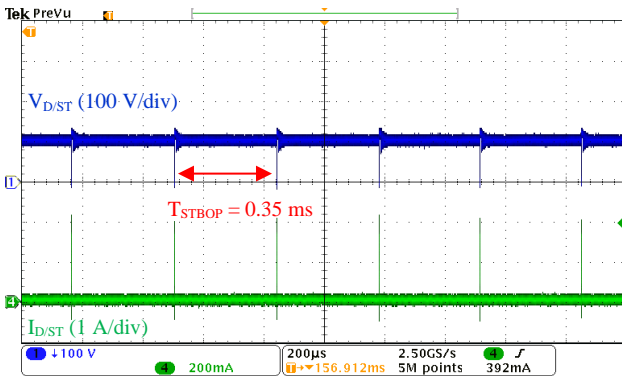

Figure 9-13. Operational Waveforms at No Load ($V_{IN} = 85 \text{ VAC}$, $I_O = 0 \text{ A}$)

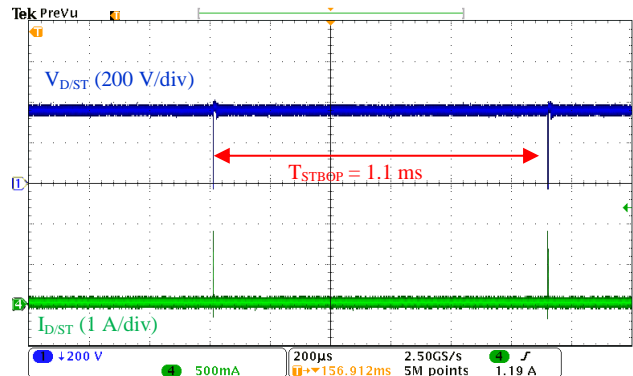

Figure 9-14. Operational Waveforms at No Load ($V_{IN} = 265 \text{ VAC}$, $I_O = 0 \text{ A}$)

9.3 Output Ripple Voltage

The design example has an output ripple voltage of about 35 mV. Below are the measurement conditions:

- Added a filter to the output connector of the PCB (by connecting a 50 V, 1 μ F electrolytic capacitor and a 50 V, 0.1 μ F ceramic capacitor in parallel)
- Set a bandwidth of the oscilloscope to 20 MHz

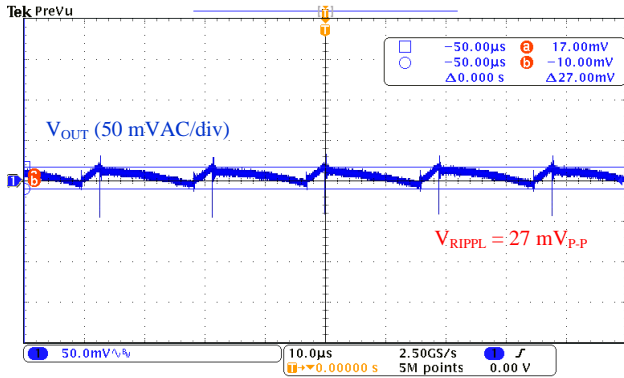

Figure 9-15. Output Ripple Voltage Waveform
($V_{IN} = 85$ VAC, $I_O = 0.7$ A)

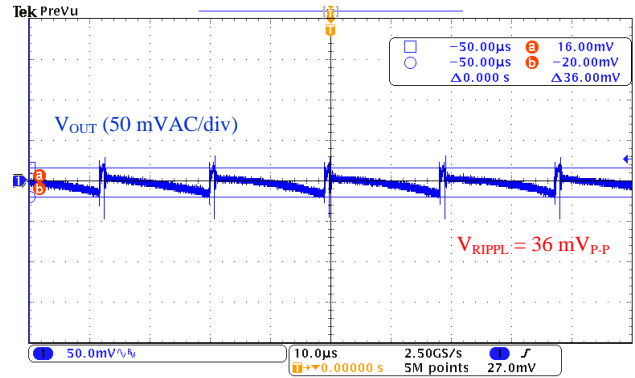

Figure 9-16. Output Ripple Voltage Waveform
($V_{IN} = 265$ VAC, $I_O = 0.7$ A)

9.4 OCP and OLP Operations

When the power supply IC reaches a certain load level, the overcurrent protection (OCP) limits the internal power MOSFET drain current, I_{DST} , to the drain current limit, I_{DLIM} . The equation below defines the relationship between I_{DLIM} and the current-sensing resistor R1:

$$I_{DLIM} = \frac{V_{OCP(H)}}{R1} \tag{9-1}$$

Where:

$V_{OCP(H)}$ is the OCP threshold voltage when STR5A453D = 36% duty cycle, and
 R1 is the resistance of the current-sensing resistor R1.

When an overload condition limited by I_{DLIM} persists for the delay time, $t_{OLP} = 70 \text{ ms}$ (typ.) or longer, the overload protection (OLP) is activated to stop switching operations. The bias assist function is disabled during the OLP operation. After the switching operations stopped, when the VCC pin voltage decreases to $V_{CC(OFF)} = 8.0 \text{ V}$ (typ.), the control circuit stops operating. In the OLP operation, such intermittent operation is repeated by the UVLO function. And this suppresses an increase in the temperature of the power MOSFET. When the causes of the overload condition are eliminated, the power supply IC automatically returns to its normal operation.

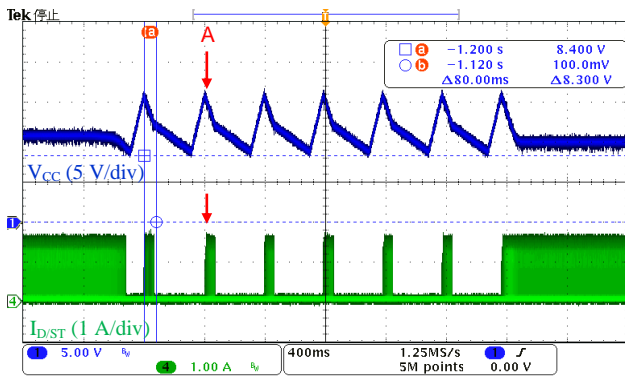

Figure 9-17. OCP and OLP Operational Waveforms ($V_{IN} = 85 \text{ VAC}$, $I_O > 0.7 \text{ A}$)

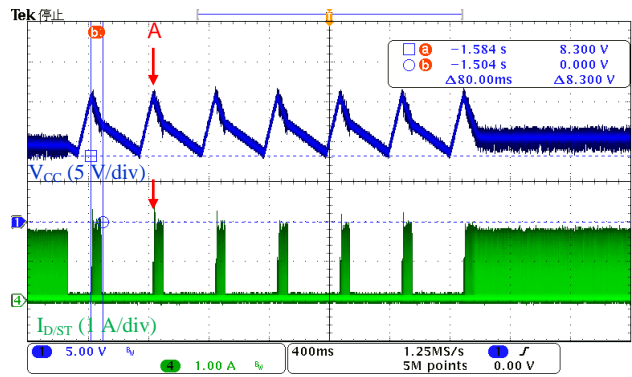

Figure 9-18. OCP and OLP Operational Waveforms ($V_{IN} = 265 \text{ VAC}$, $I_O > 0.7 \text{ A}$)

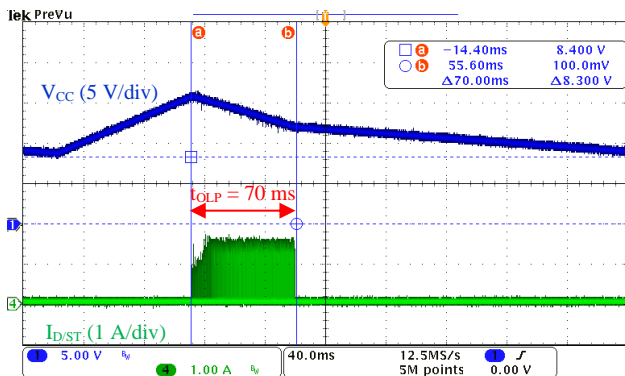

Figure 9-19. OCP and OLP Operational Waveforms (Expanded Scale of A in Figure 9-17)

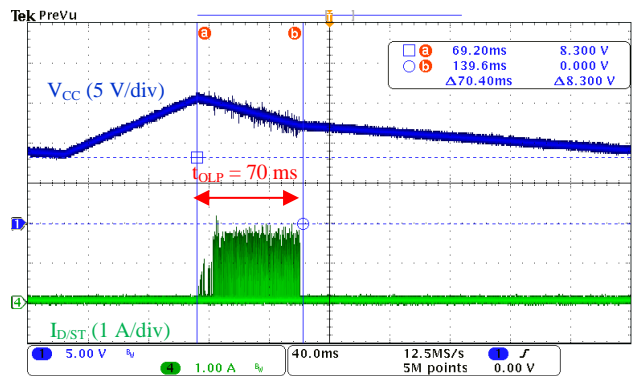

Figure 9-20. OCP and OLP Operational Waveforms (Expanded Scale of A in Figure 9-18)

9.5 OVP Operation

When the voltage between the VCC and S/GND pins of the power supply IC increases to the OVP threshold voltage, $V_{CC(OVP)} = 29.3 \text{ V}$ (typ.) or more, the overvoltage protection (OVP) is activated and power supply IC shifts to the OVP operation. In the OVP operation, an intermittent oscillation operation is repeated by the UVLO function of the VCC pin. When the causes of the overvoltage condition are eliminated, the power supply IC automatically returns to its normal operation.

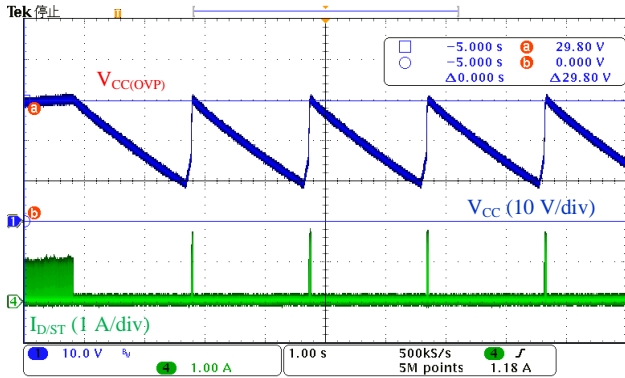

Figure 9-21. OVP Operational Waveforms ($V_{IN} = 85 \text{ VAC}$, $I_O = 0 \text{ A}$)

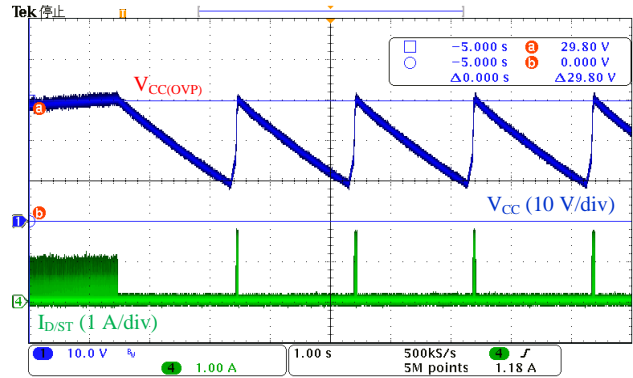

Figure 9-22. OVP Operational Waveforms ($V_{IN} = 265 \text{ VAC}$, $I_O = 0 \text{ A}$)

9.6 Shutdown Operation

When an AC power supply is cut off, the output voltage, V_{OUT} , will have an overshoot. Even though the dummy resistor R5 can adjust an increase in the output voltage, be sure to conduct actual board operation checking because R5 also affects the power loss during standby operation. As we set $R5 = 6.8 \text{ k}\Omega$ for the design example, the output voltage has an overshoot of about 1.1 V at shutdown.

After the AC power supply cutoff, the reason V_{OUT} continues to occur for about 7.5 seconds is due to the residual charges of C9 and C10.

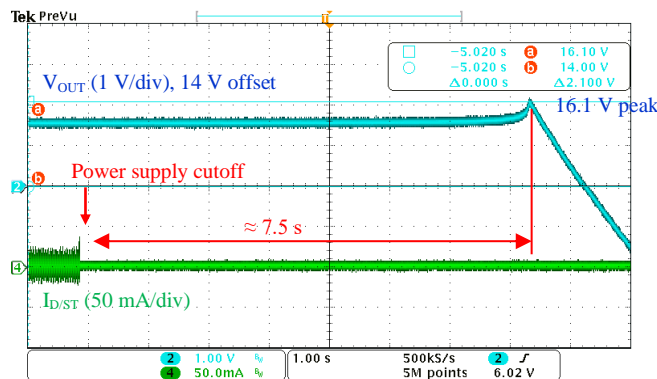

Figure 9-23. Operational Waveforms at No Load ($V_{IN} = 85 \text{ VAC}$, $I_O = 0 \text{ A}$)

9.7 Case Temperature

Table 9-1 lists the individual component case temperatures at input voltage upper and lower limits, measured under the ambient temperatures 25 °C and 50 °C respectively.

Table 9-1. Input Voltage vs. Component Case Temperature ($I_o = 0.7$ A)

Ambient Temperature (°C)	Input Voltage (VAC)	Case Temperatures in Normal Operation (°C)		
		Power Supply IC (U1)	Freewheeling Diode (D1)	Inductor (L2)
25	85	54.3	60.8	54.7
	265	63.8	64.8	66.4
50*	85	79.3	85.8	79.7
	265	88.8	89.8	91.4

* Refers to case temperatures converted from the ones at an ambient temperature of 25 °C.

10. Conducted Emission Test

Figure 10-1 to Figure 10-4 show the measurement results of mains terminal disturbance voltage (EMI).
 Measurement conditions: $I_O = 0.7\text{ A}$, FG = open
 Test mode: Average

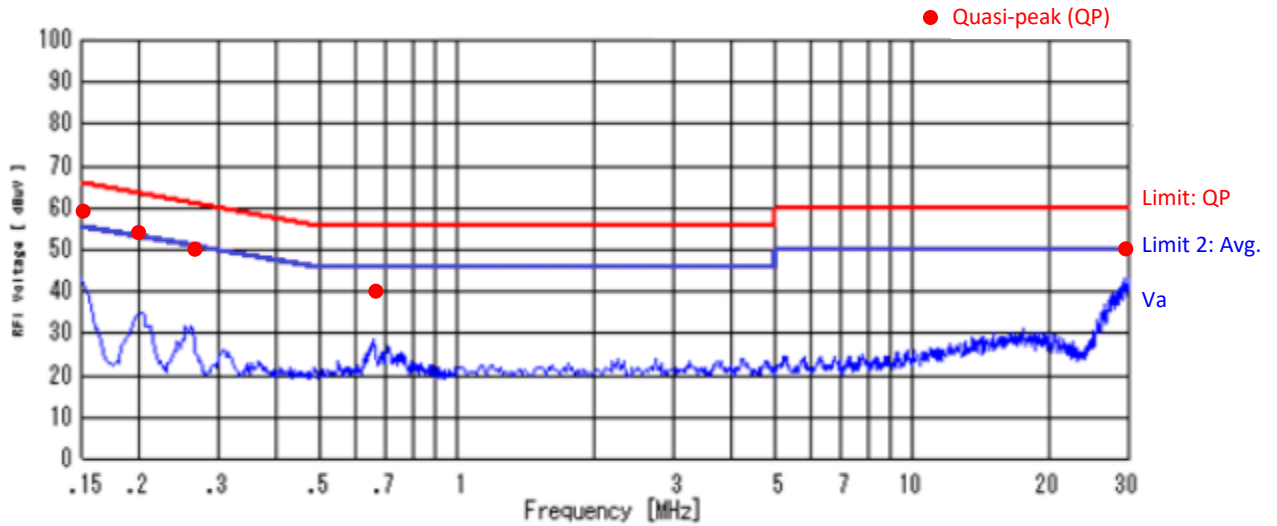

Figure 10-1. EMI Measurement Result (Line, $V_{IN} = 100\text{ VAC}$)

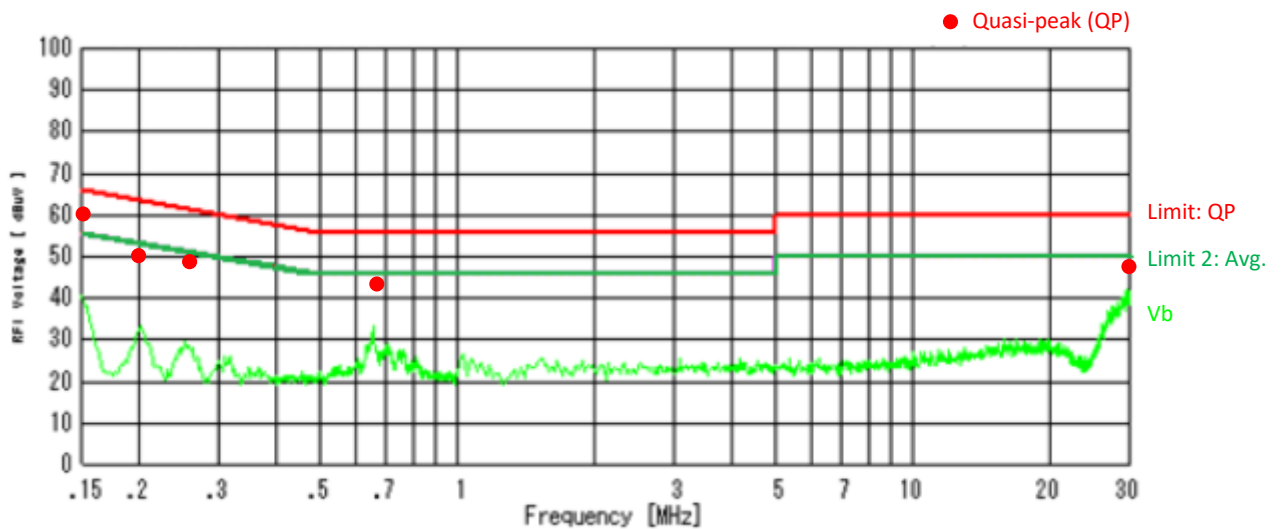

Figure 10-2. EMI Measurement Result (Neutral, $V_{IN} = 100\text{ VAC}$)

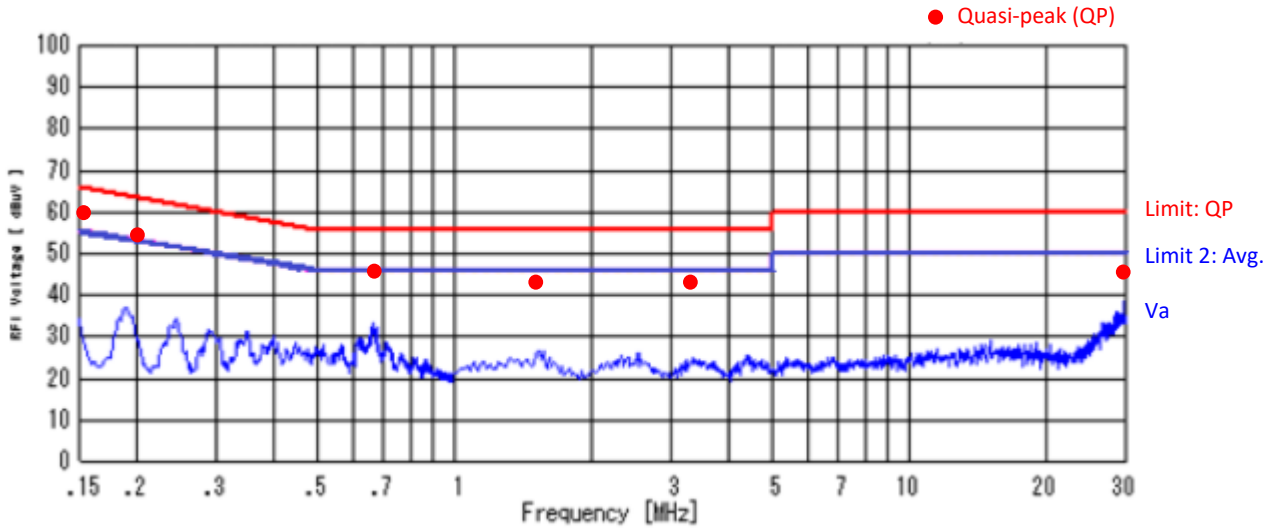

Figure 10-3. EMI Measurement Result (Line, $V_{IN} = 230$ VAC)

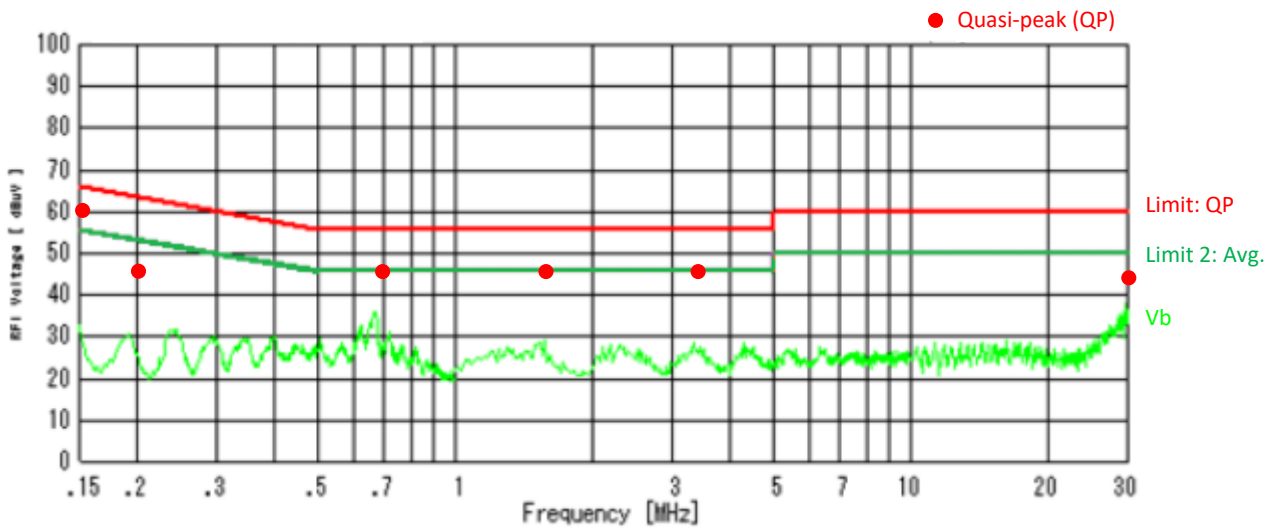

Figure 10-4. EMI Measurement Result (Neutral, $V_{IN} = 230$ VAC)

Important Notes

- All data, illustrations, graphs, tables and any other information included in this document (the “Information”) as to Sanken’s products listed herein (the “Sanken Products”) are current as of the date this document is issued. The Information is subject to any change without notice due to improvement of the Sanken Products, etc. Please make sure to confirm with a Sanken sales representative that the contents set forth in this document reflect the latest revisions before use.
- The Sanken Products are intended for use as components of general purpose electronic equipment or apparatus (such as home appliances, office equipment, telecommunication equipment, measuring equipment, etc.). Prior to use of the Sanken Products, please put your signature, or affix your name and seal, on the specification documents of the Sanken Products and return them to Sanken. When considering use of the Sanken Products for any applications that require higher reliability (such as transportation equipment and its control systems, traffic signal control systems or equipment, disaster/crime alarm systems, various safety devices, etc.), you must contact a Sanken sales representative to discuss the suitability of such use and put your signature, or affix your name and seal, on the specification documents of the Sanken Products and return them to Sanken, prior to the use of the Sanken Products. The Sanken Products are not intended for use in any applications that require extremely high reliability such as: aerospace equipment; nuclear power control systems; and medical equipment or systems, whose failure or malfunction may result in death or serious injury to people, i.e., medical devices in Class III or a higher class as defined by relevant laws of Japan (collectively, the “Specific Applications”). Sanken assumes no liability or responsibility whatsoever for any and all damages and losses that may be suffered by you, users or any third party, resulting from the use of the Sanken Products in the Specific Applications or in manner not in compliance with the instructions set forth herein.
- In the event of using the Sanken Products by either (i) combining other products or materials or both therewith or (ii) physically, chemically or otherwise processing or treating or both the same, you must duly consider all possible risks that may result from all such uses in advance and proceed therewith at your own responsibility.
- Although Sanken is making efforts to enhance the quality and reliability of its products, it is impossible to completely avoid the occurrence of any failure or defect or both in semiconductor products at a certain rate. You must take, at your own responsibility, preventative measures including using a sufficient safety design and confirming safety of any equipment or systems in/for which the Sanken Products are used, upon due consideration of a failure occurrence rate and derating, etc., in order not to cause any human injury or death, fire accident or social harm which may result from any failure or malfunction of the Sanken Products. Please refer to the relevant specification documents and Sanken’s official website in relation to derating.
- No anti-radioactive ray design has been adopted for the Sanken Products.
- The circuit constant, operation examples, circuit examples, pattern layout examples, design examples, recommended examples, all information and evaluation results based thereon, etc., described in this document are presented for the sole purpose of reference of use of the Sanken Products.
- Sanken assumes no responsibility whatsoever for any and all damages and losses that may be suffered by you, users or any third party, or any possible infringement of any and all property rights including intellectual property rights and any other rights of you, users or any third party, resulting from the Information.
- No information in this document can be transcribed or copied or both without Sanken’s prior written consent.
- Regarding the Information, no license, express, implied or otherwise, is granted hereby under any intellectual property rights and any other rights of Sanken.
- Unless otherwise agreed in writing between Sanken and you, Sanken makes no warranty of any kind, whether express or implied, including, without limitation, any warranty (i) as to the quality or performance of the Sanken Products (such as implied warranty of merchantability, and implied warranty of fitness for a particular purpose or special environment), (ii) that any Sanken Product is delivered free of claims of third parties by way of infringement or the like, (iii) that may arise from course of performance, course of dealing or usage of trade, and (iv) as to the Information (including its accuracy, usefulness, and reliability).
- In the event of using the Sanken Products, you must use the same after carefully examining all applicable environmental laws and regulations that regulate the inclusion or use or both of any particular controlled substances, including, but not limited to, the EU RoHS Directive, so as to be in strict compliance with such applicable laws and regulations.
- You must not use the Sanken Products or the Information for the purpose of any military applications or use, including but not limited to the development of weapons of mass destruction. In the event of exporting the Sanken Products or the Information, or providing them for non-residents, you must comply with all applicable export control laws and regulations in each country including the U.S. Export Administration Regulations (EAR) and the Foreign Exchange and Foreign Trade Act of Japan, and follow the procedures required by such applicable laws and regulations.
- Sanken assumes no responsibility for any troubles, which may occur during the transportation of the Sanken Products including the falling thereof, out of Sanken’s distribution network.
- Although Sanken has prepared this document with its due care to pursue the accuracy thereof, Sanken does not warrant that it is error free and Sanken assumes no liability whatsoever for any and all damages and losses which may be suffered by you resulting from any possible errors or omissions in connection with the Information.
- Please refer to our official website in relation to general instructions and directions for using the Sanken Products, and refer to the relevant specification documents in relation to particular precautions when using the Sanken Products.
- All rights and title in and to any specific trademark or tradename belong to Sanken and such original right holder(s).

DSGN-CEZ-16003